

super uno

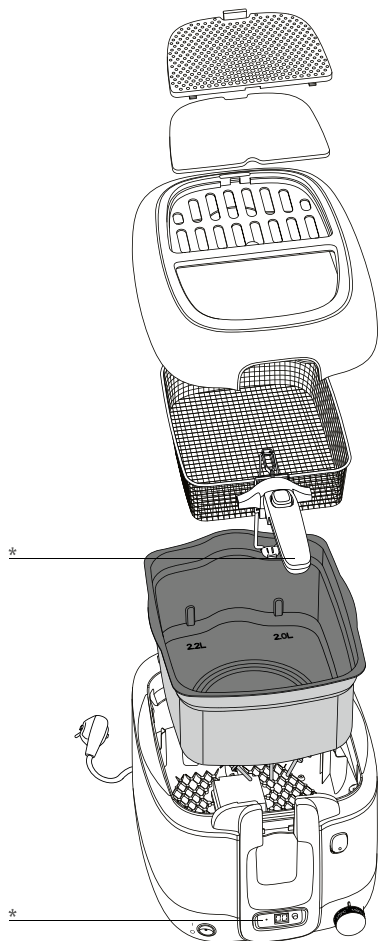

www.groupeseb.com



* Selon modèle • Afhankelijk van het model • Je nach Modell • Depending on model • Secondo i modelli • Según modelo • Consoante o modelo • ανάλογα με το μοντέλο • Modelle göre • Afhængig af model • Beroende på modell • Avhenger av modell • Mallista riippuen • Ovisno o modelu • Zavisno od modela • в зависимости от модели • Odvisno od modela • W zależności od typu • Podle modelu • V závislosti od modelu • Modelltól függően • В зависимости от модели • Залежно від моделі • Ovisno o modelu • Sõltuvalt mudelist • Atbilstoši modelim • Pagal modelius • حسب الموديل • بحسب مدل • afhængig af modellen • beroende på modell • avhengig av modell • mallista riippuen • залежно від моделі • үлгіге байланысты • vastavalt mudelitele • atkarībā no modeļa • pagal modelius • zależnie od modelu • у зависимости од модела • glede na model • zavisno od modela • в зависимости от модели • in functie de model • 視乎型號而定 • 모델에 따라 다름 • 根據型號而定 • bergantung pada model

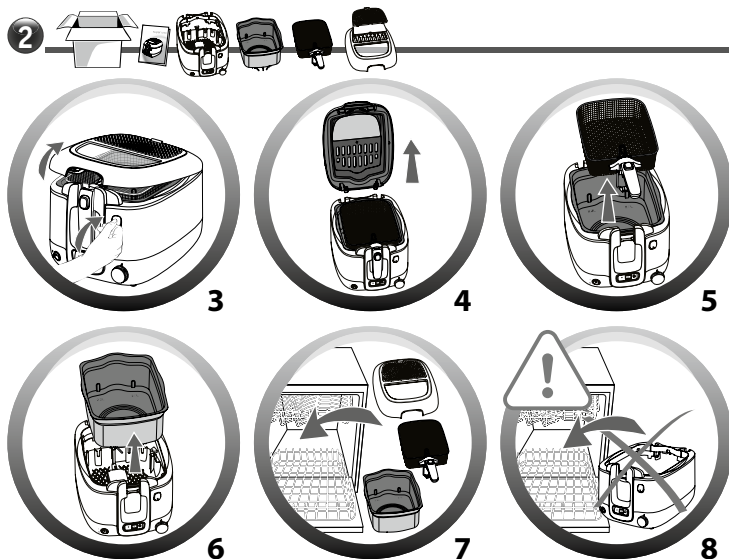
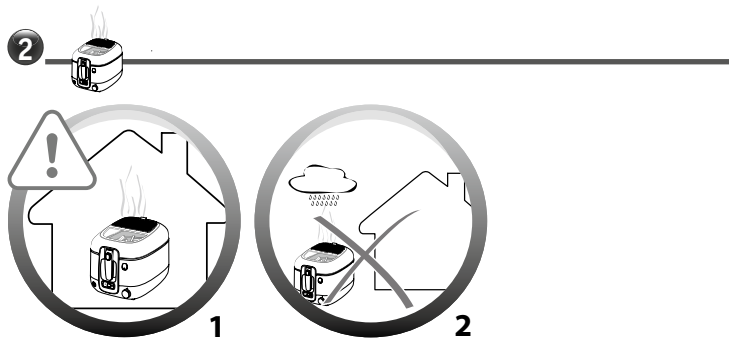

2

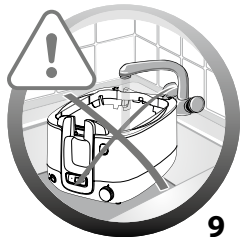
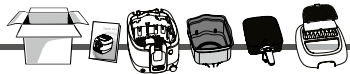

9

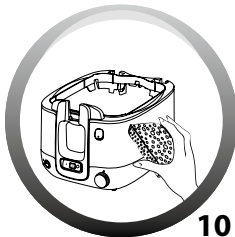

10

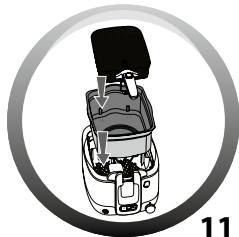

11

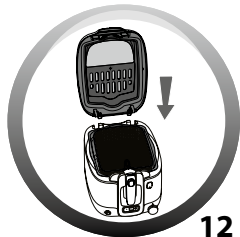

12

3

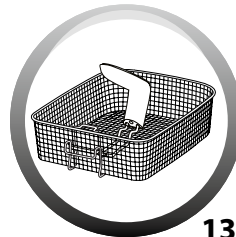

13

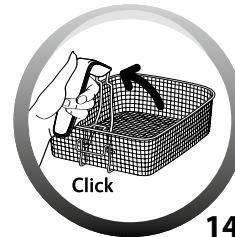

Click

14



Click

15

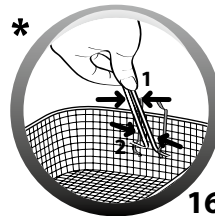

16

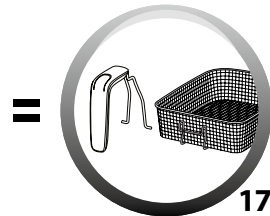

17

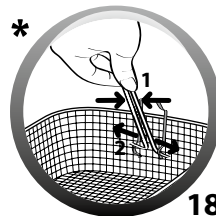

18

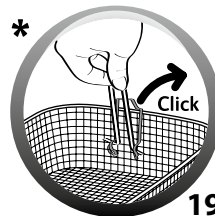

19

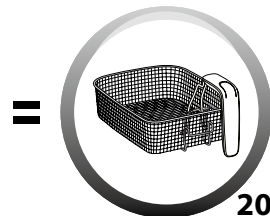

20

4

Min. 2 L / Max. 2,2 L

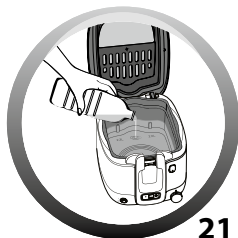
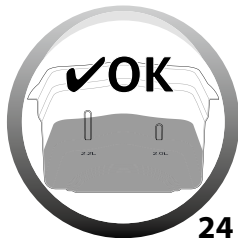
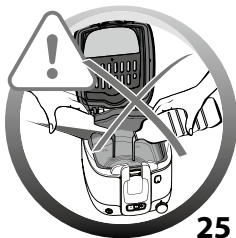
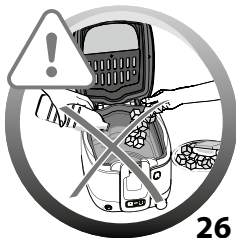
**21****22****23****24****25****26****5**

Min. 1,75 Kg / Max. 2 Kg

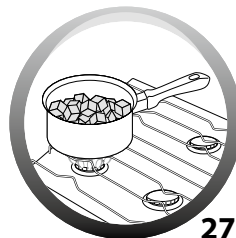
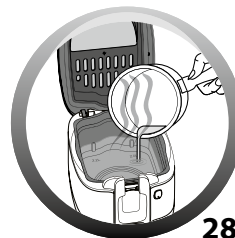
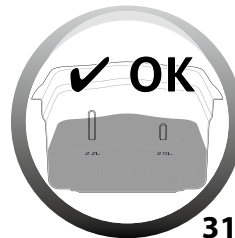
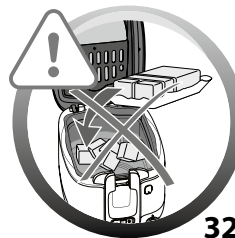
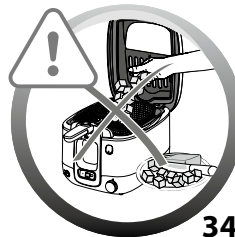
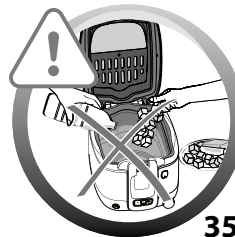
**27****28****29****30****31****32****33****34****35**

6



Max 1,4 Kg

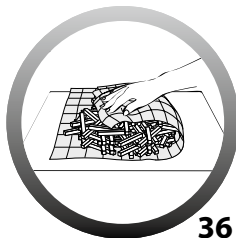

36

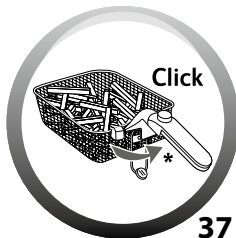

37



38



Max 1 Kg

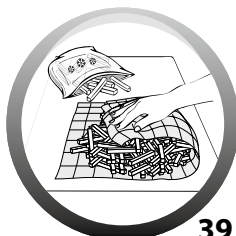

39

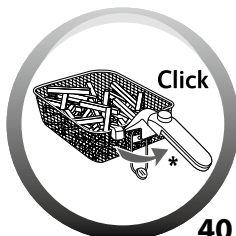

40



41

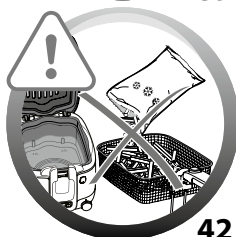

42

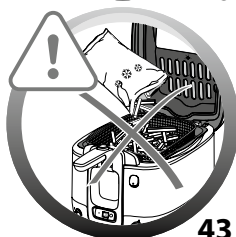

43

8

7

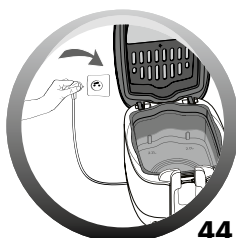

44

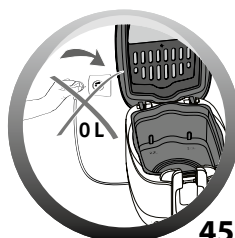

45

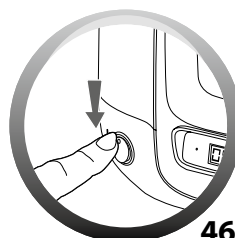

46

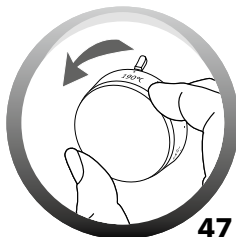

47

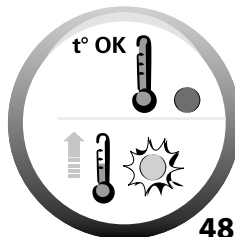

48

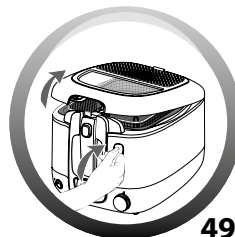

49

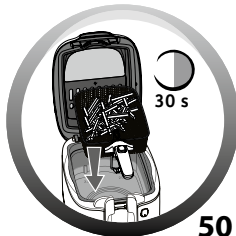

50

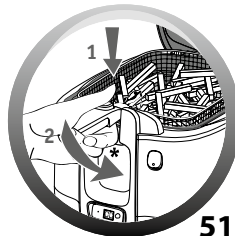

51

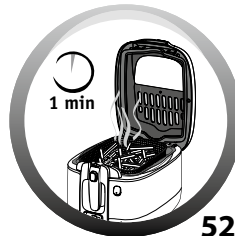

52

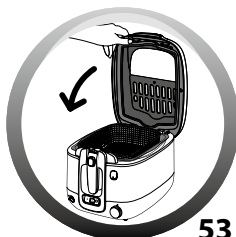

53

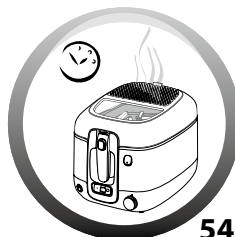

54

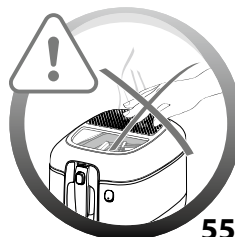

55

9

8



	Nb			
		1400 g	1) 170°C 2) 190°C	10-12 min 8-10 min
		1300 g	190°C	19-22 min
	5		180°C	14-16 min
	2		170°C	4-6 min
	8-10		190°C	4-5 min
	7		170°C	2-4 min
	8		170°C	2-3 min
	6		180°C	2 x 2 min
	Nb			
		1000 g	190°C	14-17 min
		1500 g	190°C	9-11 min
		150 g	180°C	4-5 min
	8		180°C	3-5 min
	11		190°C	4-5 min
	10		180°C	2-3 min
	5		180°C	4-5 min

10

9

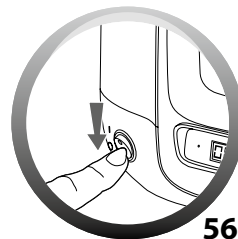

56

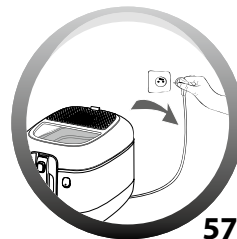

57

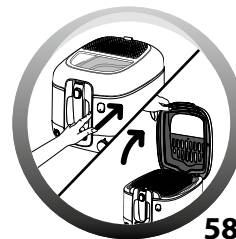

58



59

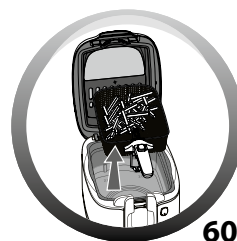

60

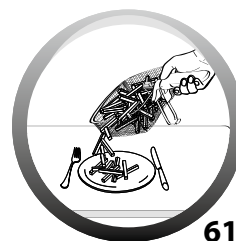

61

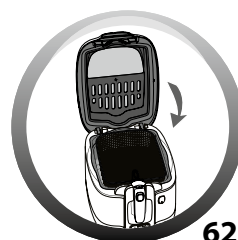

62

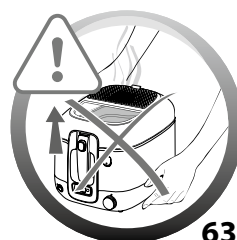

63

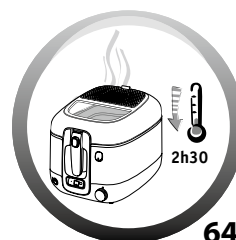

64

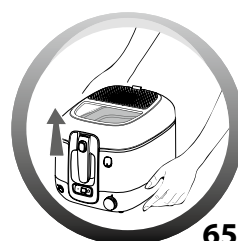

65

11

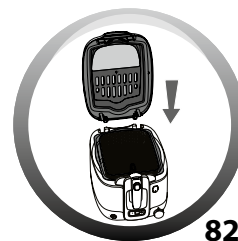
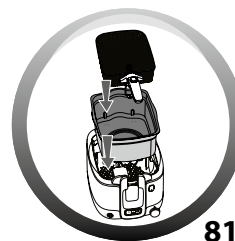
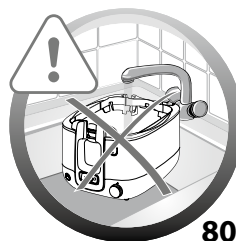
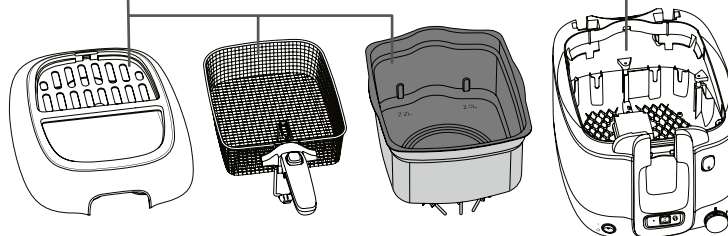
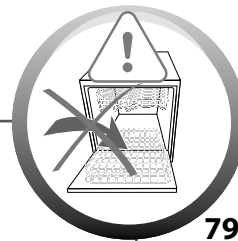
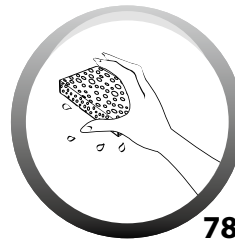
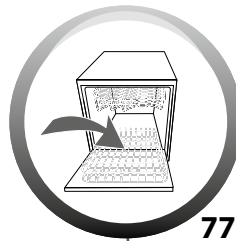
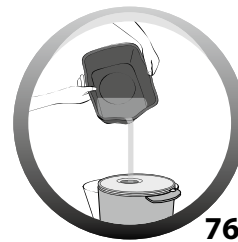
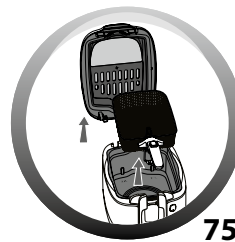
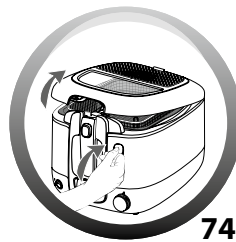
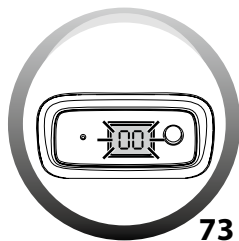
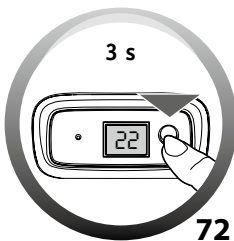
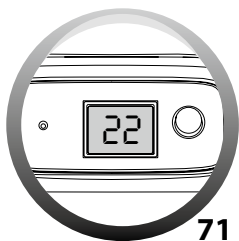
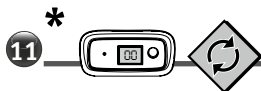
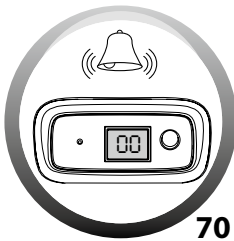
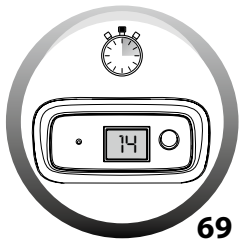
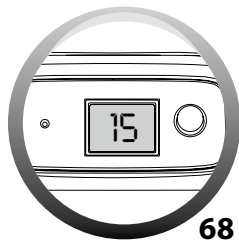
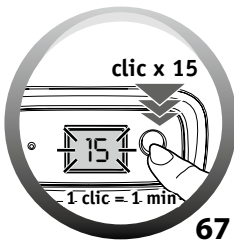
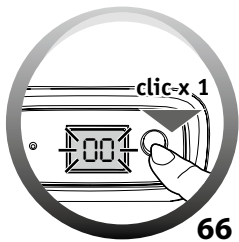

13



12 x
Max

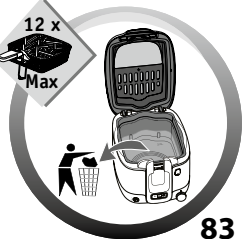

83

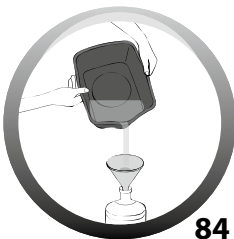

84



85

14



80 x
Max

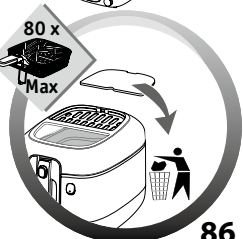

86

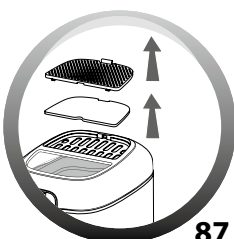

87



88

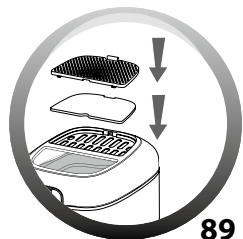

89

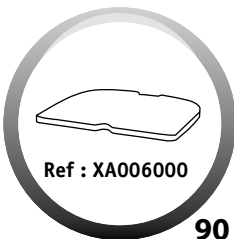

90



91

15

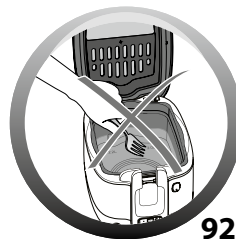

92



93



94

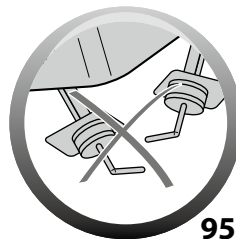

95

