

# GLOBO

## LIGHTING

### 17019H

B

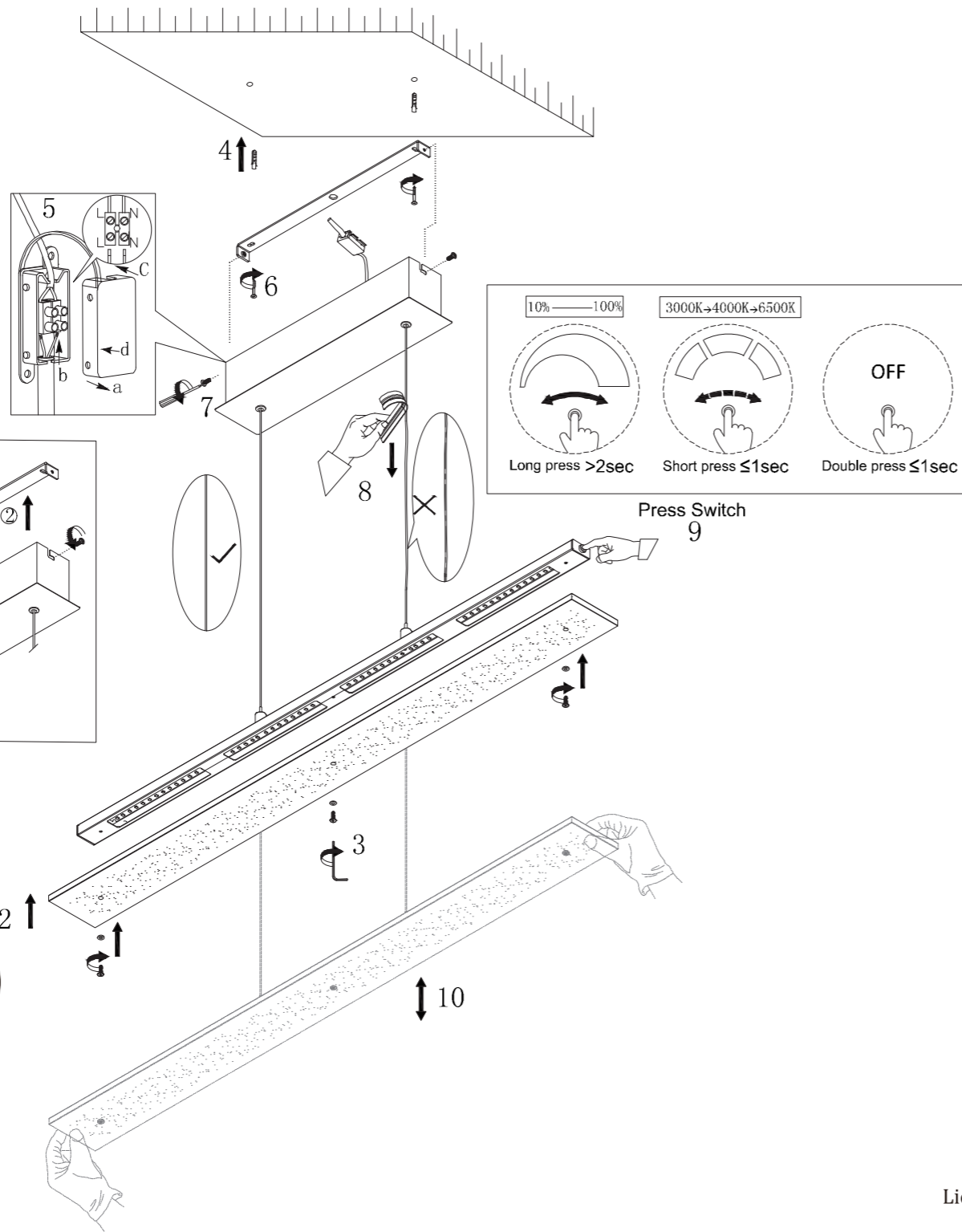

LED MAX 20W 24V  
230V~ 50/60Hz

GLOBO Handels GmbH  
Gewerbestr. 3, A-9184 Sankt Peter, AUSTRIA  
www.globo-lighting.com | office@globo-lighting.com

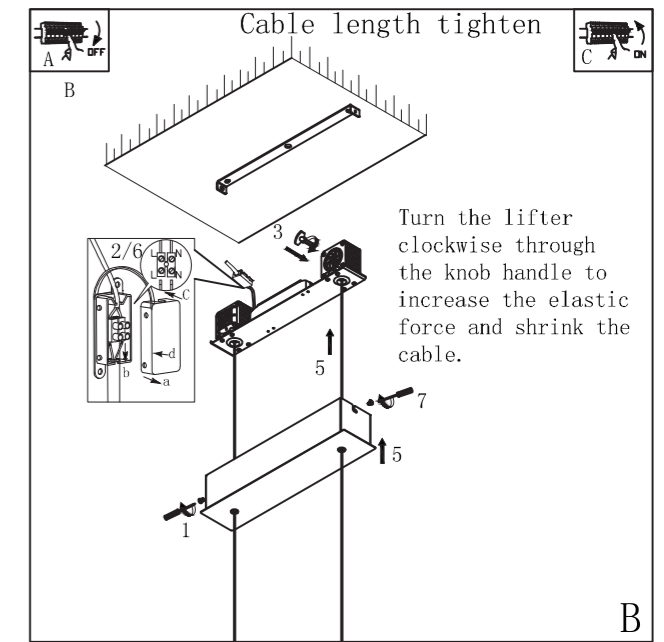
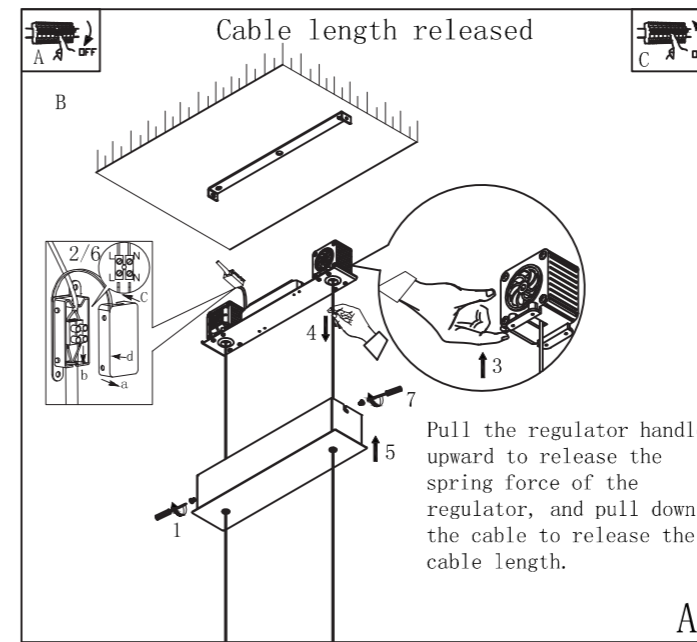
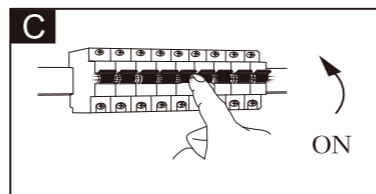

### Light source disassembly diagram

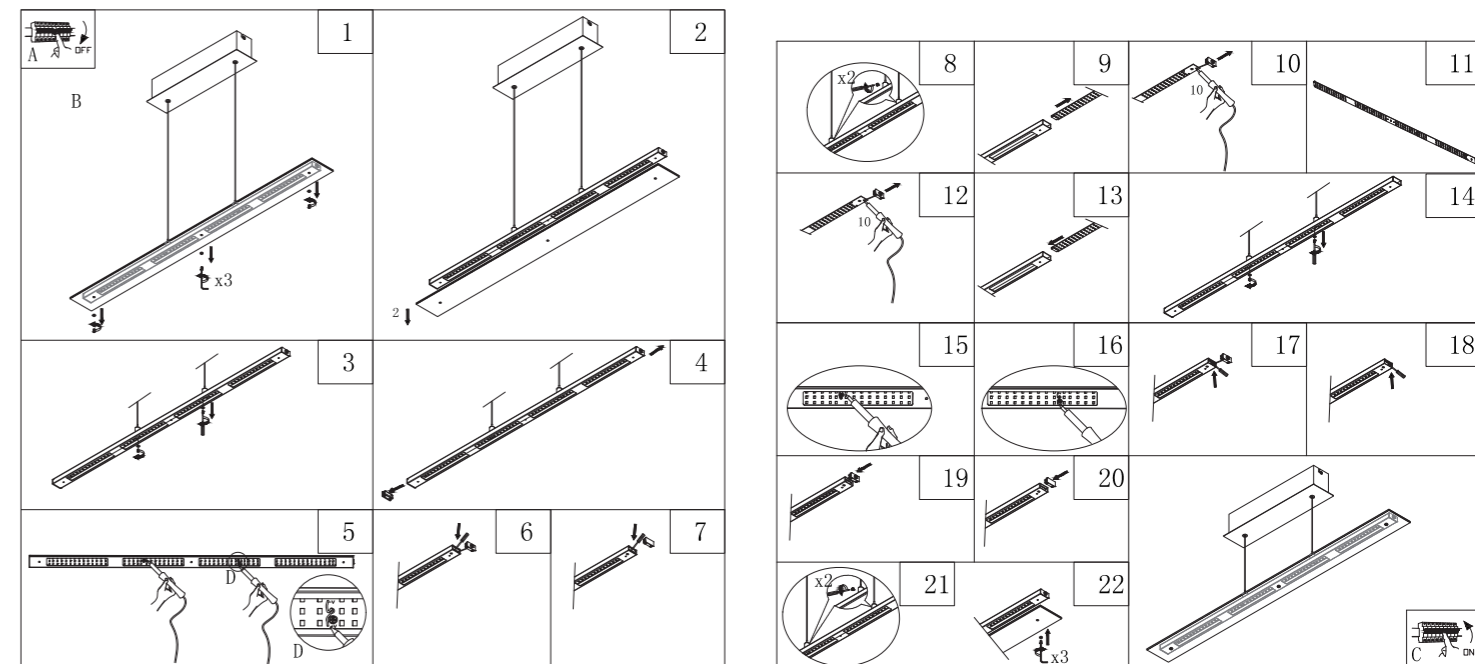

Lichtquelle/Light Source:

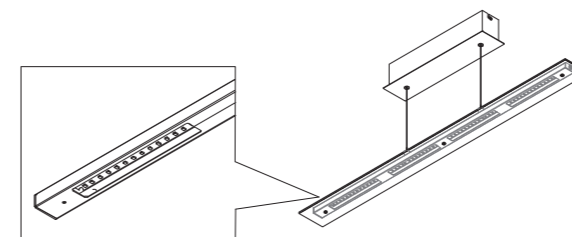

DEU:  
Lichtquelle:  
Dieses Produkt enthält eine Lichtquelle der Energieeffizienzklasse <F>.

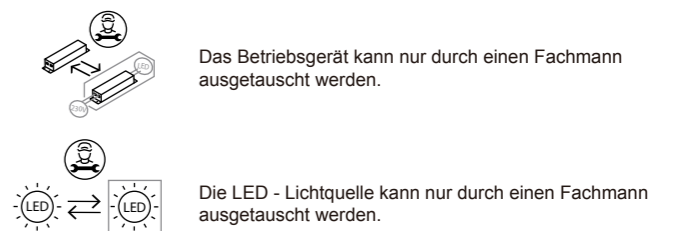

GBR:  
Light source:  
This product contains a light source of energy efficiency class <F>.

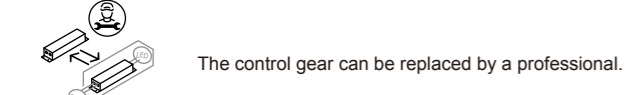

The control gear can be replaced by a professional.

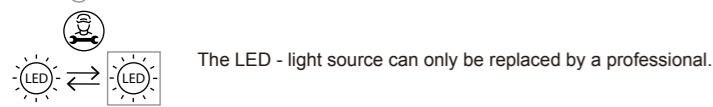

The LED - light source can only be replaced by a professional.

BIH:  
Izvor svjetla :  
Ovaj proizvod sadrži izvor svjetlosti klase energetske učinkovitosti <F>.

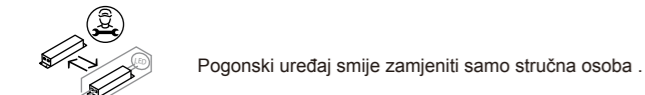

Pogonski uređaj smije zamjeniti samo stručna osoba .

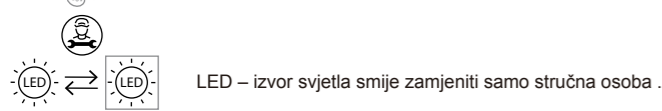

LED – izvor svjetla smije zamjeniti samo stručna osoba .

BG:  
Източник на светлина:  
Този продукт включва светлинен източник с клас на енергийна ефективност <F>.

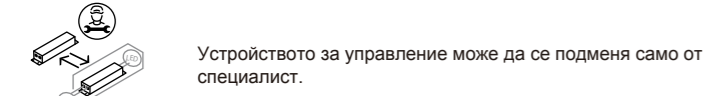

Устройството за управление може да се подменя само от специалист.

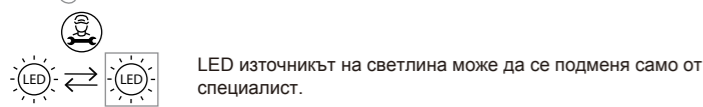

LED източникът на светлина може да се подменя само от специалист.

CZ:  
Zdroj světla:  
Tento výrobek obsahuje světelný zdroj s třídou energetické účinnosti <F>.

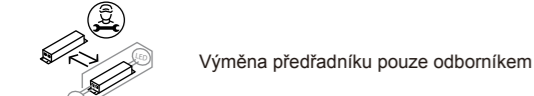

Výměna předřadníku pouze odborníkem

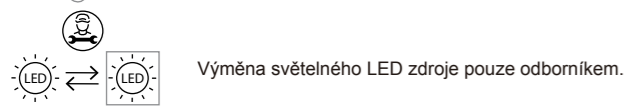

Výměna světelného LED zdroje pouze odborníkem.

DK:  
Lyskilde:  
Dette produkt indeholder en lyskilde i energieeffektivitetsklasse <F>.

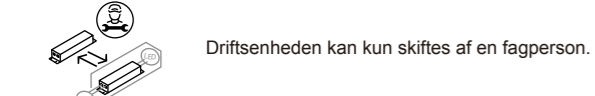

Driftsenheden kan kun skiftes af en fagperson.

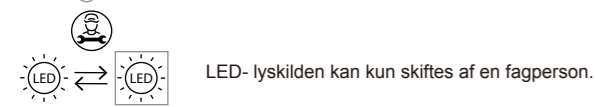

LED- lyskilden kan kun skiftes af en fagperson.

ET:  
Valgusallikas:  
Toode sisaldab energiatõhususe klassi <F> valgusallikat.

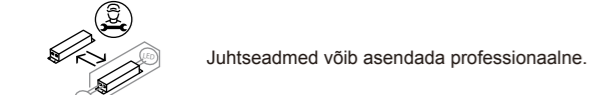

Juhtseadmed võib asendada professionaalne.

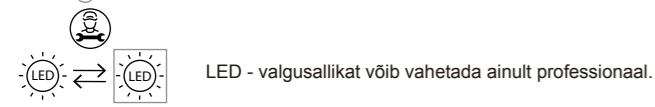

LED - valgusallikat võib vahetada ainult professionaal.

FI:  
Valonlähde:  
Tämä tuote sisältää valonlähteen, jonka energiatehokkuusluokka on <F>.

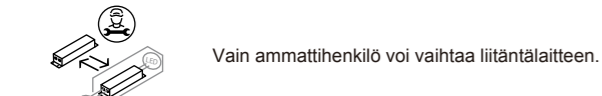

Vain ammattihenkilö voi vaihtaa liitäntälaitteen.



Vain ammattihenkilö voi vaihtaa LED-valonlähteen.

FR:  
Source lumineuse:  
Ce produit contient une source lumineuse de classe d'efficacité énergétique <F>.

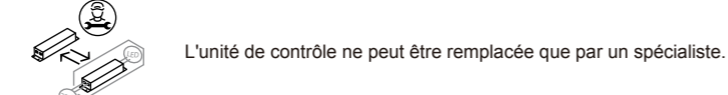

L'unité de contrôle ne peut être remplacée que par un spécialiste.

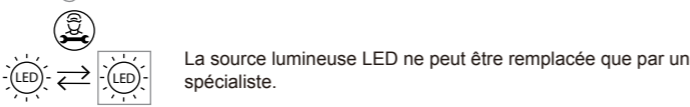

La source lumineuse LED ne peut être remplacée que par un spécialiste.

GR:  
Φωτεινή πηγή:  
Το προϊόν αυτό περιέχει φωτεινή πηγή της τάξης ενεργειακής απόδοσης <F>.

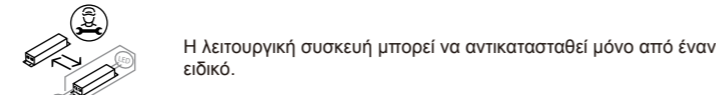

Η λειτουργική συσκευή μπορεί να αντικατασταθεί μόνο από έναν ειδικό.

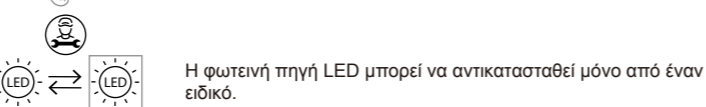

Η φωτεινή πηγή LED μπορεί να αντικατασταθεί μόνο από έναν ειδικό.

HU:  
Fényforrás:  
Ez a termék egy <F> energiatékonysági osztályú fényforrást tartalmaz.

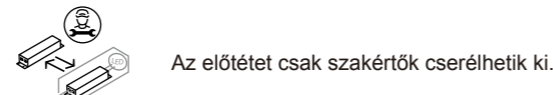

Az előtétet csak szakértők cserélhetik ki.

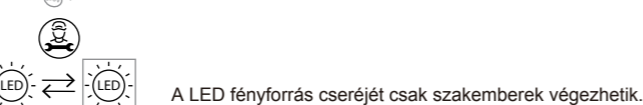

A LED fényforrás cseréjét csak szakemberek végezhetik.

Isländisch/IS:  
Ljósgrjafi:  
Varan inniheldur ljósgrjafa í orkuflokki <F>.

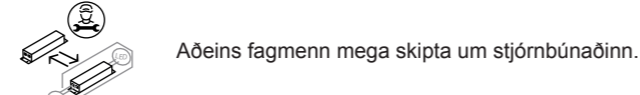

Aðeins fagmenn mega skipta um stjórnbúnaðinn.

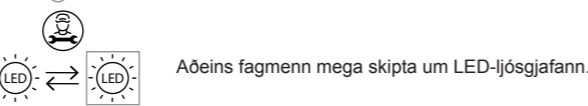

Aðeins fagmenn mega skipta um LED-ljósgrjafann.

IT:  
Sorgente luminosa:  
Questo prodotto contiene una sorgente luminosa di classe di efficienza energetica <F>.

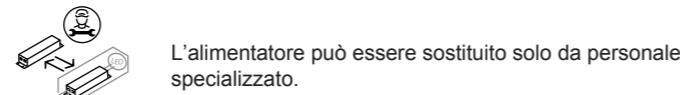

L'alimentatore può essere sostituito solo da personale specializzato.

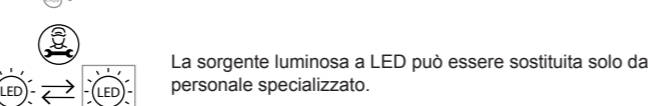

La sorgente luminosa a LED può essere sostituita solo da personale specializzato.

HR:  
Izvor svjetla:  
Ovaj proizvod sadrži izvor svjetlosti klase energetske učinkovitosti <F>.

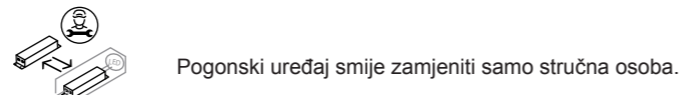

Pogonski uređaj smije zamjeniti samo stručna osoba.

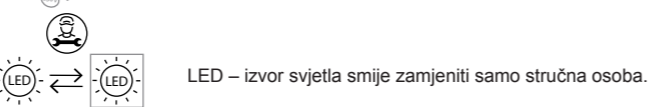

LED – izvor svjetla smije zamjeniti samo stručna osoba.

LV:  
Gaismas avots:  
Šis ražojums satur gaismas avotu, kura energoefektivitātes klase ir <F>.

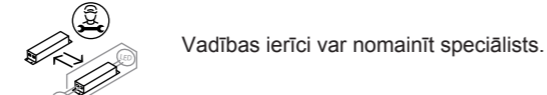

Vadības ierīci var nomainīt speciālists.

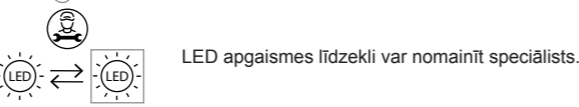

LED apgaismes līdzekli var nomainīt speciālists.

LT:  
Šviesos šaltinis:  
Šiame gaminyje yra šviesos šaltinis, kurio energijos vartojimo efektyvumo klasė <F>.

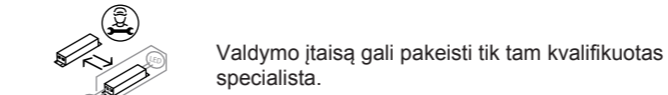

Valdymo įtaisą gali pakeisti tik tam kvalifikuotas specialistas.

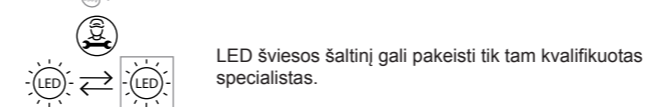

LED šviesos šaltinį gali pakeisti tik tam kvalifikuotas specialistas.

NL:  
Lichtbron:  
Dit product bevat een lichtbron van energie-efficiëntieklasse <F>.

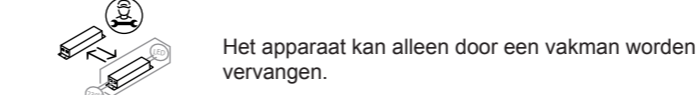

Het apparaat kan alleen door een vakman worden vervangen.

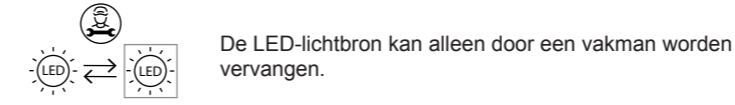

De LED-lichtbron kan alleen door een vakman worden vervangen.

Norwegisch/Norwegian / NO:  
Dette produktet inneholder en lyskilde i energiklasse <F>.

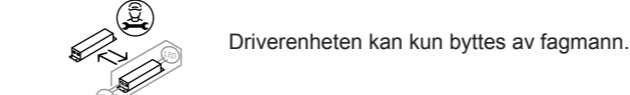

Driverenheten kan kun byttes av fagmann.

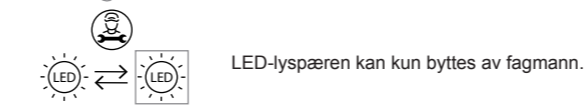

LED-lyspæren kan kun byttes av fagmann.

PL:  
Źródło światła:  
Ten produkt zawiera źródło światła o klasie efektywności energetycznej <F>.

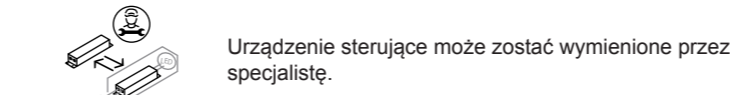

Urządzenie sterujące może zostać wymienione przez specjalistę.

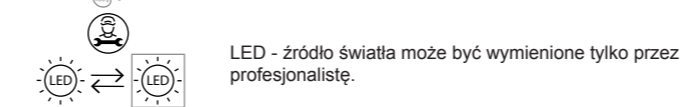

LED - źródło światła może być wymienione tylko przez profesjonalistę.

PT:  
Fonte de Luz:  
Este produto contém uma fonte de luz da classe de eficiência energética <F>.

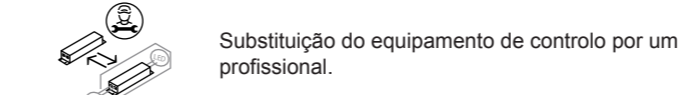

Substituição do equipamento de controlo por um profissional.

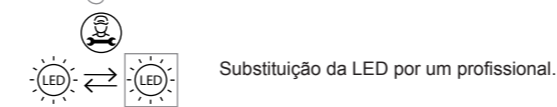

Substituição da LED por um profissional.

RO:  
Sursa de lumina:  
Acest produs conține o sursă de lumină cu clasa de eficiență energetică <F>.

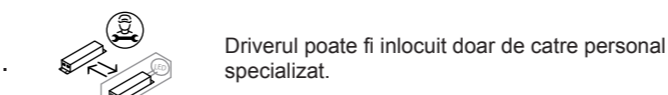

Driverul poate fi înlocuit doar de către personal specializat.

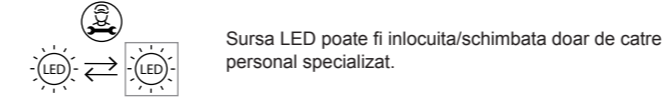

Sursa LED poate fi înlocuită/schimbata doar de către personal specializat.

RUS:  
Источник света:  
Данный продукт содержит источник света класса энергоэффективности <F>.

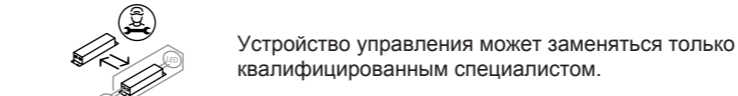

Устройство управления может заменяться только квалифицированным специалистом.

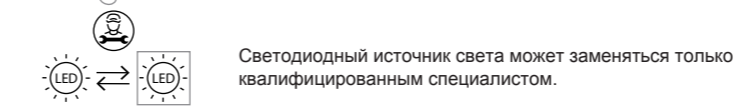

Светодиодный источник света может заменяться только квалифицированным специалистом.

SRB:  
Izvor svetlosti:  
Ovaj proizvod sadrži izvor svetlosti klase energetske efikasnosti <F>.

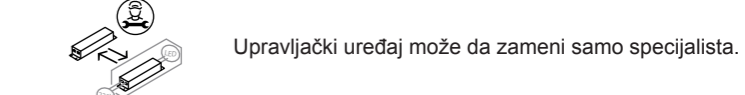

Upravljački uređaj može da zameni samo specijalista.



LED izvor svetlosti može da zameni samo specijalista.

SK:  
Zdroj svetla:  
Tento výrobok obsahuje svetelný zdroj triedy energetickej účinnosti <F>.

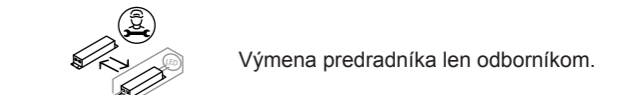

Výmena predradníka len odborníkom.

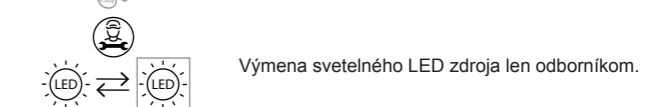

Výmena svetelného LED zdroja len odborníkom.

SI:  
Izvor svetlobe:  
Ta izdelek vsebuje svetlobni vir razreda energijske učinkovitosti <F>.

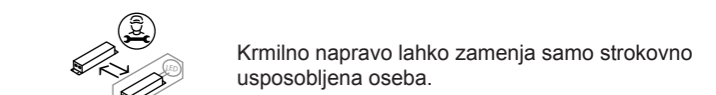

Krmilno napravo lahko zamenja samo strokovno usposobljena oseba.

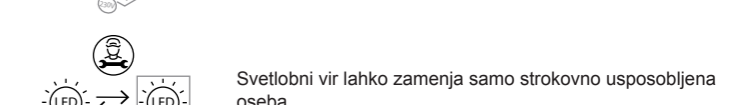

Svetlobni vir lahko zamenja samo strokovno usposobljena oseba.

ES:  
Fuente de luz:  
Este producto contiene una fuente luminosa de la clase de eficiencia energética <F>.

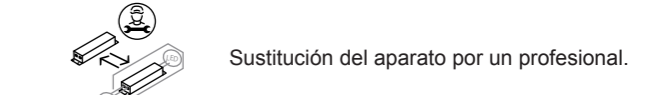

Sustitución del aparato por un profesional.

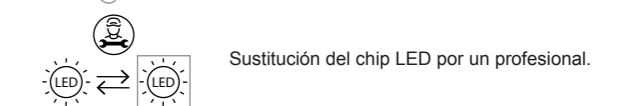

Sustitución del chip LED por un profesional.

SE:  
Ljuskälla:  
Denna produkt innehåller en ljuskälla med energieffektivitetsklass <F>.

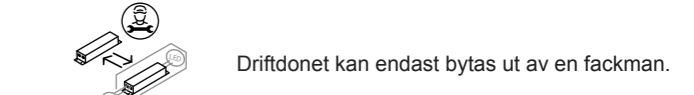

Driftdonet kan endast bytas ut av en fackman.

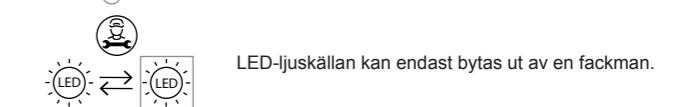

LED-ljuskällan kan endast bytas ut av en fackman.

TR:  
Işık kaynağı:  
Bu ürün, <F> enerji sınıfından bir ışık kaynağına sahiptir.

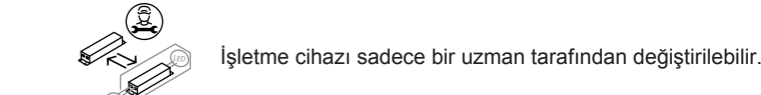

İşletme cihazı sadece bir uzman tarafından değiştirilebilir.

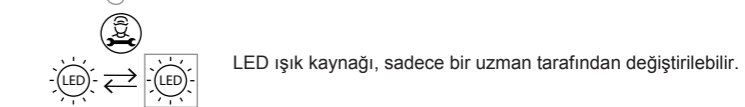

LED ışık kaynağı, sadece bir uzman tarafından değiştirilebilir.

UK:  
Джерело світла:  
Цей виріб містить джерело світла класу енергоефективності <F>.

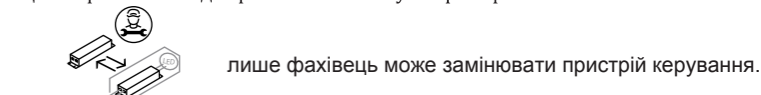

лише фахівець може замінювати пристрій керування.

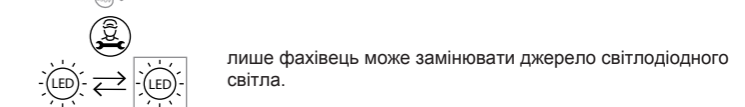

лише фахівець може замінювати джерело світлодіодного світла.