

GLOBO

LIGHTING

15915-3

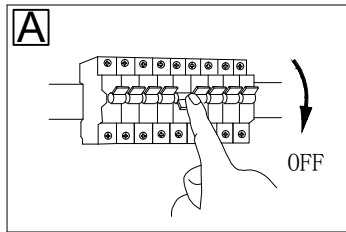

B

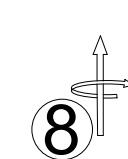
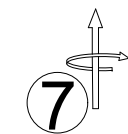
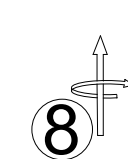
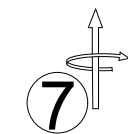
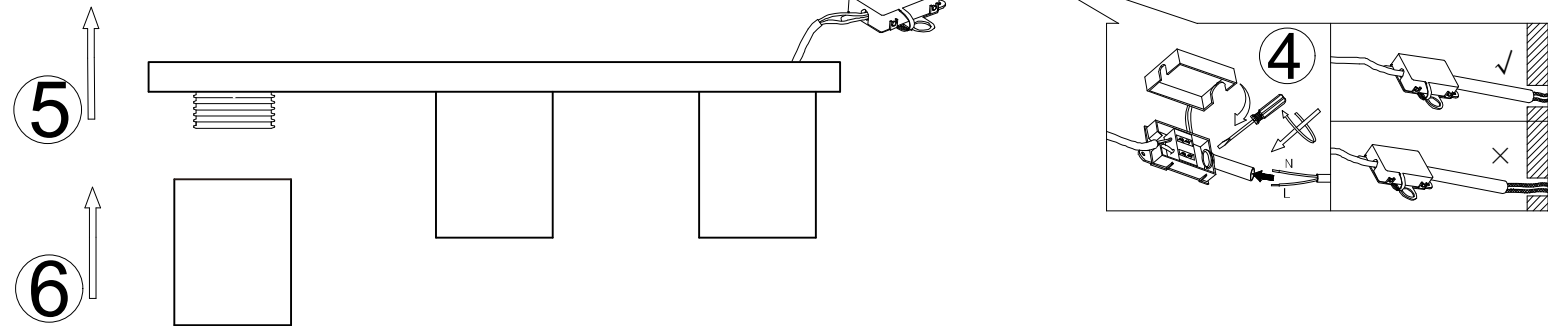
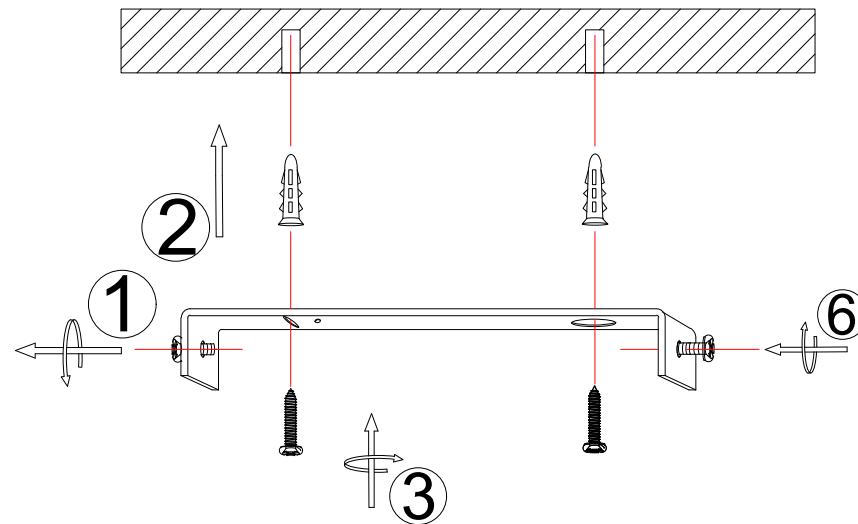

excl.

3x MAX 40W E27
230V~ 50Hz

GLOBO Handels GmbH
Gewerbestr. 3
A-9184 Sankt Peter, Austria
www.globo-lighting.com
office@globo-lighting.com

