

GLOBO

LIGHTING
www.globo-lighting.com
67179H

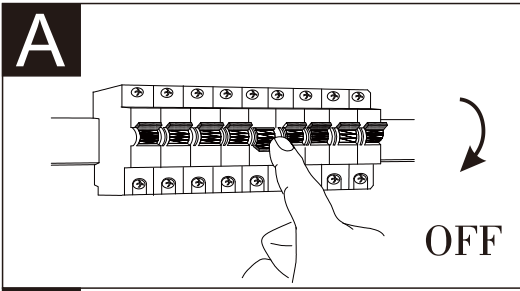

B
 LED MAX 40W 36V
 220-240V~ 50/60Hz

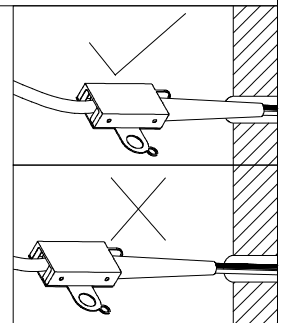
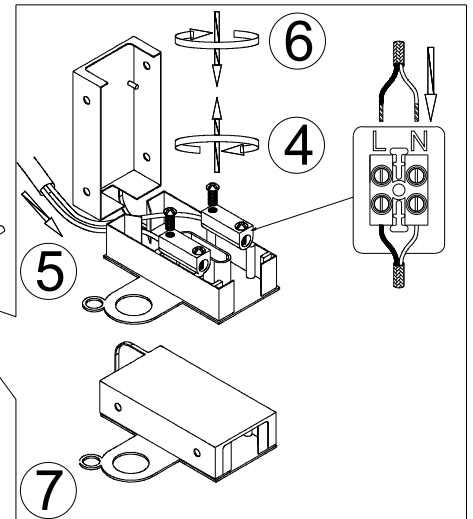
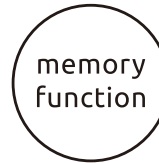
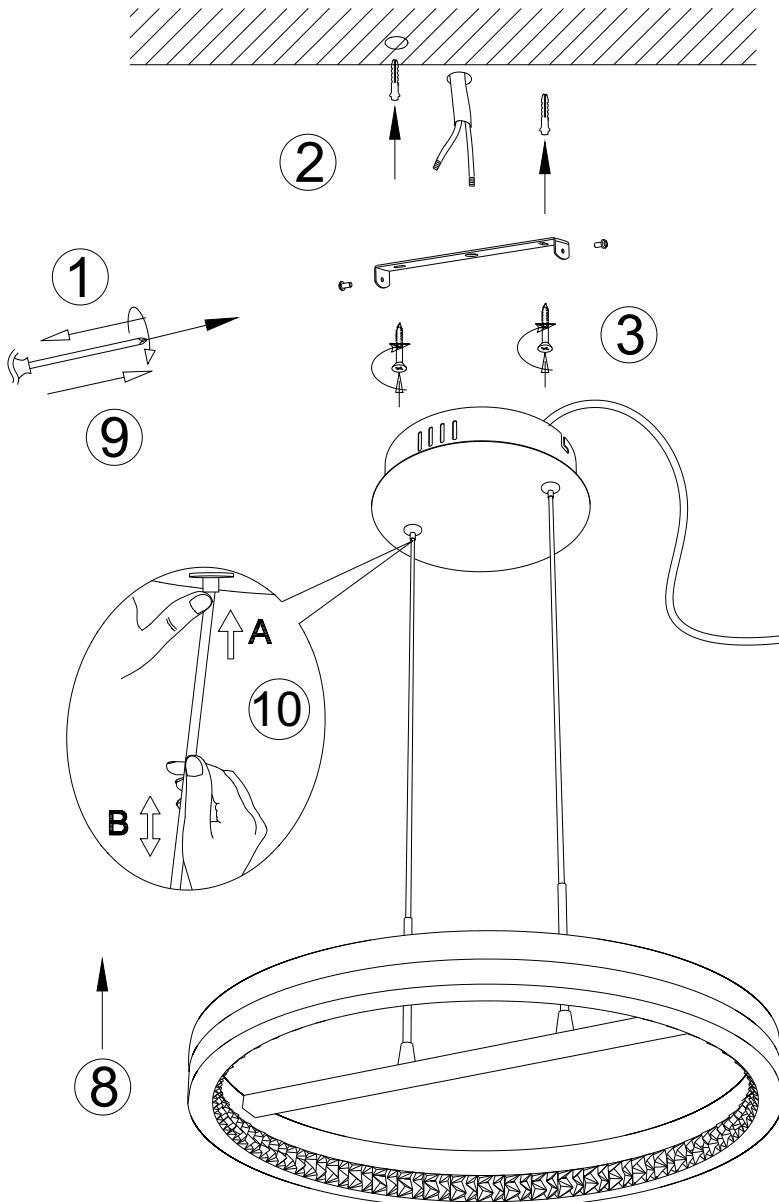

GLOBO Handels GmbH
 Gewerbestr. 3
 A-9184 Sankt Peter
 AUSTRIA
www.globo-lighting.com
office@globo-lighting.com

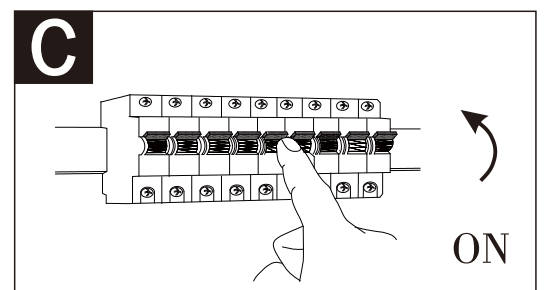

Wall switch

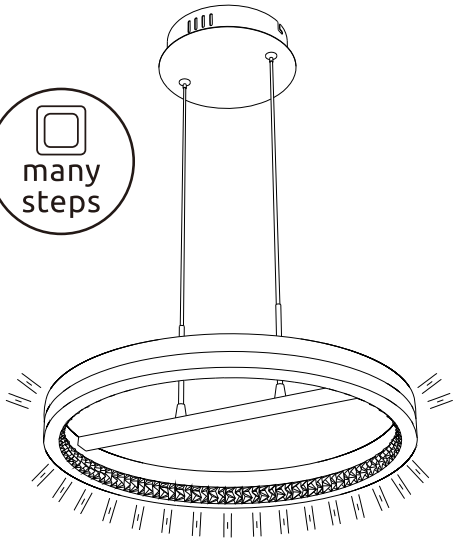
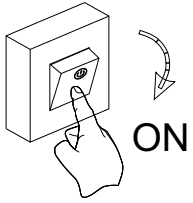

Step-1
3000K

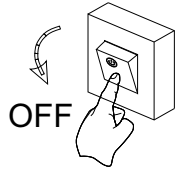

T<3sec.

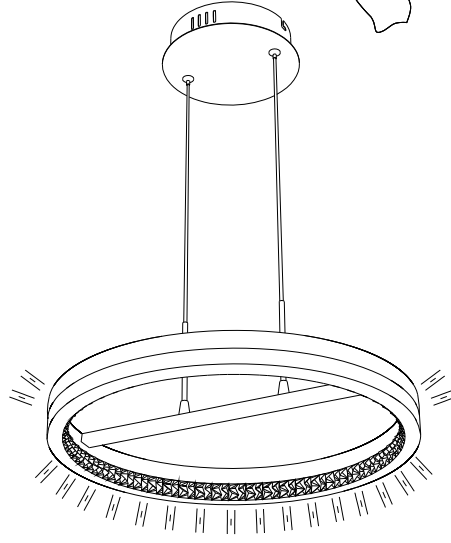
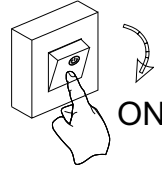

Step-2
4000K

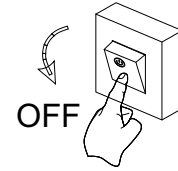

T<3sec.

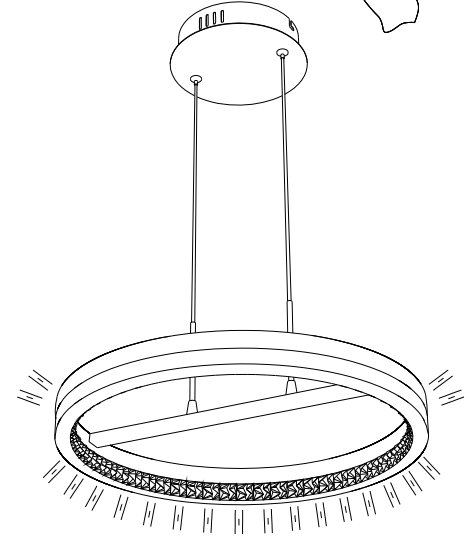
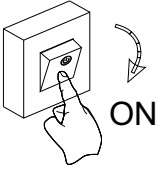

Step-3
6000K

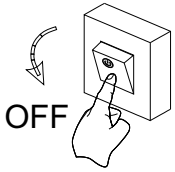

T<3sec.

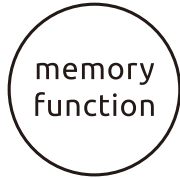
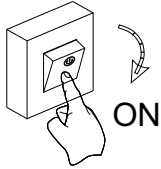

OFF

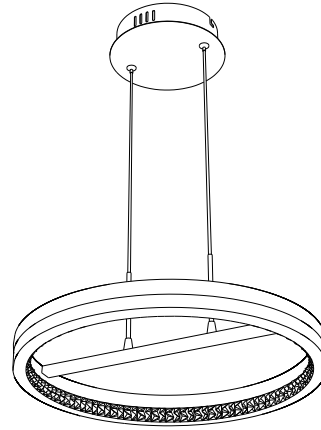

ON

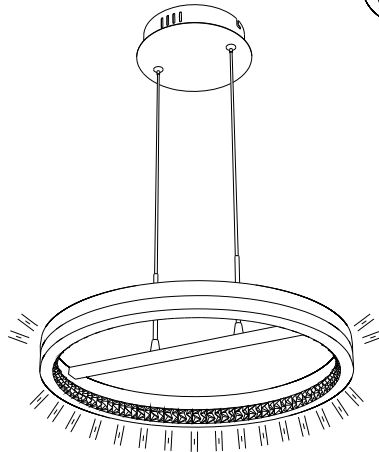

>15S

ON

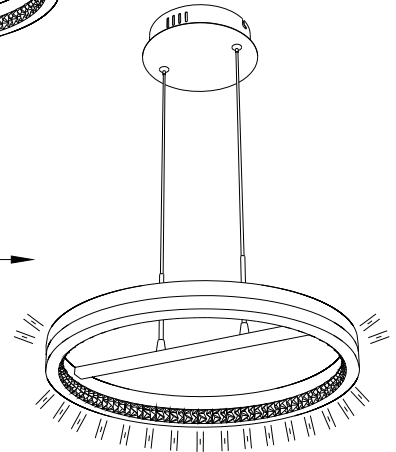

Step-4
Nightlight

Lichtquelle/Light source

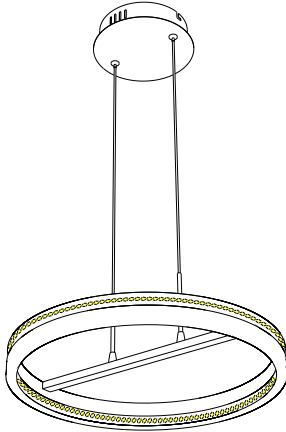

DEU:

Lichtquelle:

Die Lichtquelle ist nicht tauschbar, weil sie konstruktionsbedingt fest mit dem umgebenden Produkt verbunden ist.

Dieses Produkt enthält eine Lichtquelle der Energieeffizienzklasse <E>.

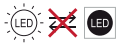

Die LED - Lichtquelle ist nicht austauschbar.

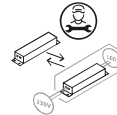

Das Betriebsgerät kann nur durch einen Fachmann ausgetauscht werden.

GBR:

Light source:

The light source is not interchangeable because it is determined by the surrounding product design. This product contains a light source of energy efficiency class < E >.

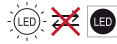

The LED - light source cannot be replaced.

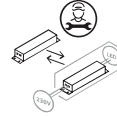

The control gear can be replaced by a professional.

BGR:

Източник на светлина:

Източникът на светлина не може да се подменя, тъй като поради конструкцията си е трайно фиксиран към заобикалящия го продукт. Този продукт включва светлинен източник с клас на енергийна ефективност <E>.



LED източникът на светлина не може да се подменя.

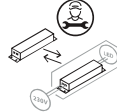

Устройството за управление може да се подменя само от специалист.

CZE:

Zdroj světla:

Světelný zdroj není možné vyměnit, protože je díky své konstrukci pevně spojený s produktem.

Tento výrobek obsahuje světelný zdroj s třídou energetické účinnosti <E>.



Světelný zdroj není vyměnitelný.



Výměna předřadníku pouze odborníkem

DNK:

Lyskilde:

Lyskilden kan ikke udskiftes, fordi den er fast forbundet med det omgivende produkt. Dette produkt indeholder en lyskilde i energieffektivitetsklasse < E >.

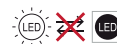

LED- lyskilden kan ikke udskiftes.

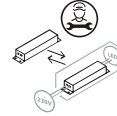

Driftsenheden kan kun skiftes af en fagperson.

ESP:

Fuente de luz:

La fuente de luz no es sustituible porque está fija en el producto desde la construcción.
Este producto contiene una fuente luminosa de la clase de eficiencia energética <E>.

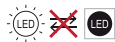

Bombilla no reemplazable.

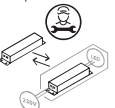

Sustitución del aparato por un profesional.

EST:

Valgusallikas:

Valgusallikas ei ole välja vahetatav, sest ta on tootega ehituslikult kindlalt seotud.
Toode sisaldab energiatõhususe klassi <E> valgusallikat.

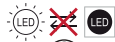

LED - valgusallikat ei saa asendada.

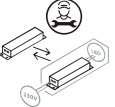

Juhtseadmed võib asendada professionaalne.

EL/GRE:

Φωτεινή πηγή:

Η φωτεινή πηγή δεν μπορεί να αντικατασταθεί, επειδή είναι για κατασκευαστικούς λόγους σταθερά συνδεδεμένη με το προϊόν που την περιβάλλει.
Το προϊόν αυτό περιέχει φωτεινή πηγή της τάξης ενεργειακής απόδοσης <E>.

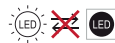

Η φωτεινή πηγή LED δεν αντικαθίσταται.

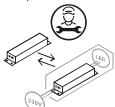

Η λειτουργική συσκευή μπορεί να αντικατασταθεί μόνο από έναν ειδικό.

FIN:

Valonlähde:

Valonlähdettä ei voi vaihtaa uuteen, sillä se on rakenteellisesti yhdistetty ympäröivään tuotteeseen.
Tämä tuote sisältää valonlähteen, jonka energiatehokkuusluokka on <E>.



LED-valonlähdettä ei voi vaihtaa uuteen.

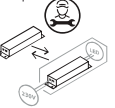

Vain ammattihenkilö voi vaihtaa liitäntälaitteen.

FRA:

Source lumineuse:

La source lumineuse n'est pas remplaçable car elle est, de par la construction du produit, liée de façon permanente à celui-ci.
Ce produit contient une source lumineuse de classe d'efficacité énergétique <E>.



La source lumineuse LED n'est pas remplaçable.

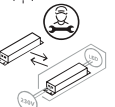

L'unité de contrôle ne peut être remplacée que par un spécialiste.

HRV :

Izvor svjetla :

Izvor svjetla nije zamjenjiv , jer je konstrukcijski pričvršćen na proizvod.
Ovaj proizvod sadržava izvor svjetlosti klase energetske učinkovitosti <E>.

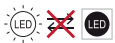

LED – izvor svjetla nije moguće zamjeniti

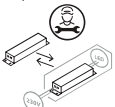

Pogonski uređaj smije zamjeniti samo stručna osoba .

HUN:

Fényforrás:

A fényforrás nem cserélhető, mert felépítése miatt szilárdan csatlakozik a termékhez

Ez a termék egy <E> energiahatékonysági osztályú fényforrást tartalmaz.

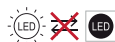

A fényforrás nem cserélhető

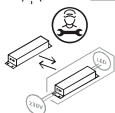

Az előtétet csak szakértők cserélhetik ki.

ISL:

Ljósgrjafi:

Ljósgrjafinn er ekki útskiptanlegur vegna þess að hann er háður umliggjandi hönnun vörunnar.

Varan inniheldur ljósgrjafa í orkuflokki <E>.

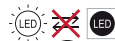

Ekki er hægt að skipta um LED-ljósgrjafann.

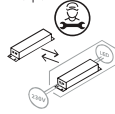

Aðeins fagmenn mega skipta um stjórnbúnaðinn..

ITA:

Sorgente luminosa:

La sorgente luminosa non è intercambiabile perché è saldamente collegata al prodotto per via del suo design.

Questo prodotto contiene una sorgente luminosa di classe di efficienza energetica <E>.

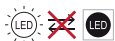

La sorgente luminosa a LED non può essere sostituita.



L'alimentatore può essere sostituito solo da personale

LT:

Šviesos šaltinis:

Šis šviesos šaltinis yra nekeičiamas, nes jis prijungtas prie gaminio pagal jo konstrukciją.

Šiame gaminyje yra šviesos šaltinis, kurio energijos vartojimo efektyvumo klasė <E>.



LED šviesos šaltinis yra nekeičiamas.

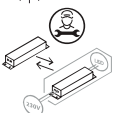

Valdymo įtaisą gali pakeisti tik tam kvalifikuotas

LVA:

Gaismas avots:

Gaismas avotu nevar nomainīt, jo tas konstrukcijā ir cieši savienots ar izstrādājuma apkārtējo daļu.

Šis ražojums satur gaismas avotu, kura energoefektivitātes klase ir <E>.



LED apgaismes līdzekli nevar nomainīt.

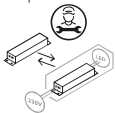

Vadības ierīci var nomainīt speciālists.

NL:

Lichtbron:

De lichtbron kan niet worden vervangen, omdat deze vanwege de constructie vast met het product eromheen verbonden is.

Dit product bevat een lichtbron van energie-efficiëntieklasse <E>.



De LED-lichtbron kan niet worden vervangen.

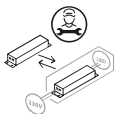

Het apparaat kan alleen door een vakman worden vervangen.

NOR:

Lyskilde:

Lyskilden kan ikke byttes fordi den sitter fast i produktet.
Dette produktet inneholder en lyskilde i energiklasse <E>.

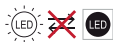

LED-lyspæren kan ikke byttes.

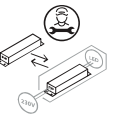

Driverenheten kan kun byttes av fagmann.

PL:

Źródło światła:

Źródła światła nie można wymienić, ponieważ jest zintegrowane z produktem ze względu na swoją konstrukcję.
Ten produkt zawiera źródło światła o klasie efektywności energetycznej <E>.

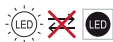

LED - źródło światła nie może być wymienione.

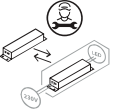

Urządzenie sterujące może zostać wymienione przez

POR:

Fonte de Luz:

A fonte de luz não é substituível porque devido às suas características construtivas está fixada de forma permanente ao produto circundante.
Este produto contém uma fonte de luz da classe de eficiência energética <E>.



Lâmpada não substituível.

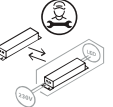

Substituição do equipamento de controlo por um profissional.

RO

Sursa de lumina:

Sursa de lumina nu este inlocuibilă ea fiind parte constructivă a produsului
Acest produs conține o sursă de lumină cu clasa de eficiență energetică <E>.



Sursa de lumina nu poate fi înlocuită

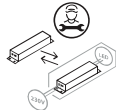

Driverul poate fi înlocuit doar de către personal specializat

RUS:

Источник света:

Источник света не является взаимозаменяемым, поскольку это определяется конструкцией смежного продукта.
Данный продукт содержит источник света класса энергоэффективности <E>.

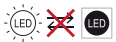

Светодиодный источник света не подлежит замене.

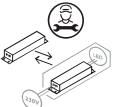

Устройство управления может заменяться только квалифицированным специалистом.

SK:

Zdroj svetla:

Svetelný zdroj nie je možné vymeniť, pretože je vďaka svojej konštrukcii pevne spojený s produktom.
Tento výrobok obsahuje svetelný zdroj triedy energetickej účinnosti <E>.

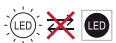

Svetelný zdroj nie je vymeniteľný.

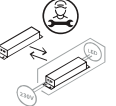

Výmena predradníka len odborníkom.

SRB:

Izvor svetlosti:

Izvor svetlosti nije zamenljiv, jer je zbog svog dizajna čvrsto povezan sa proizvodom koji ga opkružuje.

Ovaj proizvod sadrži izvor svetlosti klase energetske efikasnosti <E>.

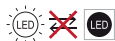

LED izvor svetlosti nije zamenljiv.

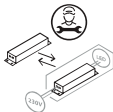

Upravljački uređaj može da zameni samo specijalista.

SWE

Ljuskälla:

Ljuskällan är inte utbytbar, eftersom den på grund av konstruktionen är fast integrerad i den omgivande produkten.

Denna produkt innehåller en ljuskälla med energieffektivitetsklass <E>.

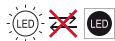

LED-ljuskällan kan inte bytas ut.

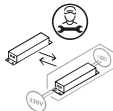

Driftdonet kan endast bytas ut av en fackman.

SI:

Izvor svetlobe:

Vir svetlobe ni zamenljiv, ker je določen z zasnovno izdelka v okolici.

Ta izdelek vsebuje svetlobni vir razreda enerjske učinkovitosti <E>.

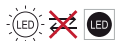

Svetlobni vir ni mogoče zamenjati.

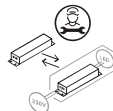

Krmilno napravo lahko zamenja samo strokovno usposobljena oseba

TUR:

Işık kaynağı:

Konstrüksiyon gereği çevreleyen ürün ile sabit bir şekilde bağlı olduğu için ışık kaynağı değiştirilemez. Bu ürün, <E> enerji sınıfından bir ışık kaynağına sahiptir.

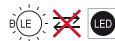

LED ışık kaynağı değiştirilemez.

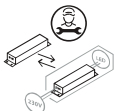

İşletme cihazı sadece bir uzman tarafından değiştirilebilir.

UA:

Джерело світла:

Джерело світла не можна обміняти, оскільки воно міцно пов'язане з навколишнім виробом завдяки своїй конструкції.

Цей виріб містить джерело світла класу енергоефективності <E>.

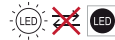

– джерело світлодіодного світла не можна замінювати.

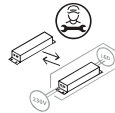

– лише фахівець може замінювати пристрій керування.